

EZ36

Tracked Zero Tail Excavators



**WACKER
NEUSON**
all it takes!



Zero tail excavator with high performance cycles

Compact and productive - The zero tail excavator EZ36 combines the technology and operator comfort of a larger machine in a powerful, yet economical 3.6-ton package. This compact excavator offers the performance of a conventional track excavator with excellent maneuverability and stability on a minimal swing machine. The EZ36 is highly productive providing best-in-class dig depth and reach.

- User-friendly operating concept, large and comfortable cab
- Four position adjustable windshield, four-way angle dozer blade
- Standard thumb bracket,
- Undercarriage for smooth ride and easy transport
- Easy maintenance and service access, heavy-duty design for long service life

EZ36 Technical specifications

EZ36

Operating data

Shipping weight min.	7,372 lb
Operating weight	7,791 - 9,811 lb
Biting force max.	4,743 lbf
Breakout force max.	7,868 lbf
Digging depth max. (long dipperstick)	137.7 in
Digging radius max. (long dipperstick)	226.3 in
Superstructure slewing speed	9.5 rev/min
L x W x H	216.7 x 68.9 x 98.1 in
Fuel tank capacity	11.6 US gal

Engine / Motor

Engine / Motor manufacturer	Yanmar Diesel engine
Engine / Motor type	3TNV88F-EPWN
Engine / Motor	water-cooled 3-cylinder suction engine
Displacement	100.2 in ³
RPM / speed	2,430 rpm
Engine performance POWER Mode	24.4 hp
Engine performance ECO mode	23.9 hp

Battery

Battery	71 CCA
---------	--------

Hydraulic system

Duty pump	2 axial piston pumps / 2 gear pumps
Max. flow rate	11.23 + 11.23 US gpm
Max. flow rate	6.29 + 2.99 US gpm
Operating pressure for working and driving hydraulics	3,481 psi
Operating pressure Drehwerk	2,828 psi
Hydraulic oil tank	17.3 US gal

Undercarriage

Travel speed max.	2.9 mph
Chain width	11.8 in
Ground clearance	9.9 in

Dozer Blade

Width	68.9 in
Height	14.1 in
Stroke dozer blade above ground	15.5 in
Stroke dozer blade below ground	19.9 in

EZ36 Dimensions

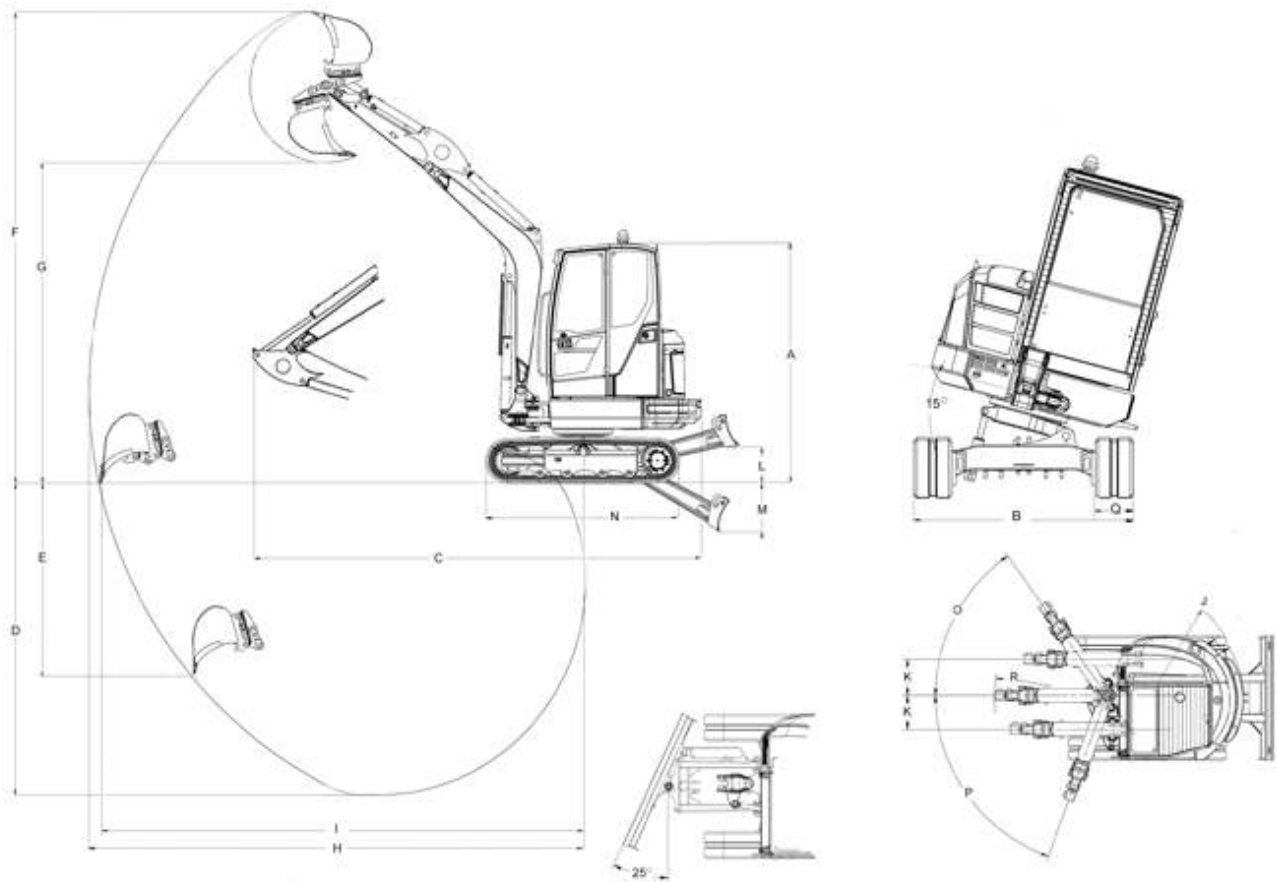

			VDS
A	Height	98.1 in	101.3 in
B	Width	68.9 in	68.9 in
Q	Width undercarriage	11.8 in	11.8 in
C	Transport length	216.82 in	216.1 in
D	Digging depth max. (short dipperstick)	216.7 in	124.98 in
D	Digging depth max. (long dipperstick)	137.78 in	134.83 in
E	Insertion depth max. vertical (short dipperstick)	83.65 in	80.69 in
E	Insertion depth max. vertical (long dipperstick)	92.98 in	90.03 in
F	Insertion height max. (short dipperstick)	194.05 in	197.16 in
F	Insertion height max. (long dipperstick)	200.23 in	203.19 in
G	Dump height max. (short dipperstick)	131.44 in	134.39 in
G	Dump height max. (long dipperstick)	137.47 in	140.42 in
H	Digging radius max. (short dipperstick)	208.74 in	207.64 in
H	Digging radius max. (long dipperstick)	219.93 in	218.51 in
I	Range on the ground max. (short dipperstick)	212.41 in	211.89 in
I	Range on the ground max. (long dipperstick)	222.26 in	221.78 in
J	Rear swivel radius min.	36.76 in	36.76 in
K	Arm displacement max. to center bucket right side	26.79 in	26.79 in

K	Arm displacement max. to center bucket left side	25.61 in	25.61 in
L	Lift height max. dozer blade above ground	15.48 in	15.48 in
M	Scraping depth max. dozer blade below ground	19.9 in	19.9 in
N	Length undercarriage	81.24 in	81.24 in
O	Turning angle max. boom to the right	45 °	45 °
P	Turning angle max. boom to the left	70 °	70 °
--	Boom slewing radius center	88.45 in	88.45 in

Please note: that product availability can vary from country to country. It is possible that information / products may not be available in your country. More detailed information on engine power can be found in the operator's manual; the stated power may vary due to specific operating conditions. Subject to alterations and errors excepted. Applicable also to illustrations.
 Copyright © 2020 Wacker Neuson SE.